

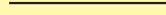



Brite-Americanano Primo Mug





Product Dimension(mm): 86dia x 100

Minimum Print Restrictions (Grip)

Line thickness (0.3mm)	
Reversed Line (0.3mm)	
Text (6pt)	
Reversed Text (10pt)	

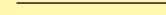
Any lines or text below these restrictions will result in a loss of detail when printed

Minimum Print Restrictions (Mug)

Line thickness (0.2mm)	
Reversed Line (0.2mm)	
Text (3pt)	
Reversed Text (4pt)	

Any lines or text below these restrictions will result in a loss of detail when printed

Actual Artwork Size(s):

Mug = 

Grip = 

Please read carefully:

Yellow tint is to show the effect of the lamination process.
Please note 'white' will not be 'pure brilliant white'

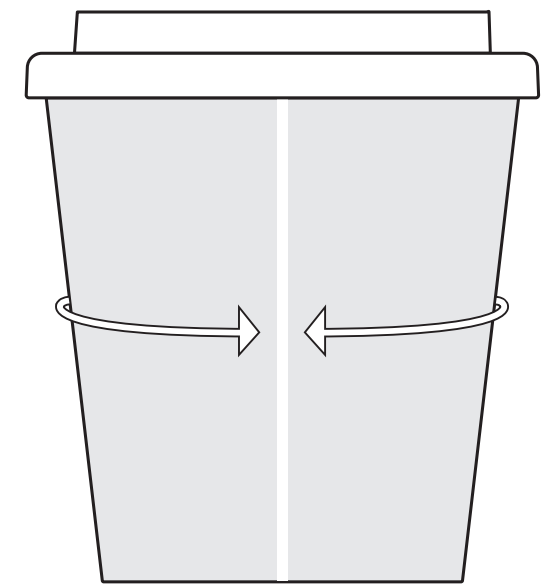
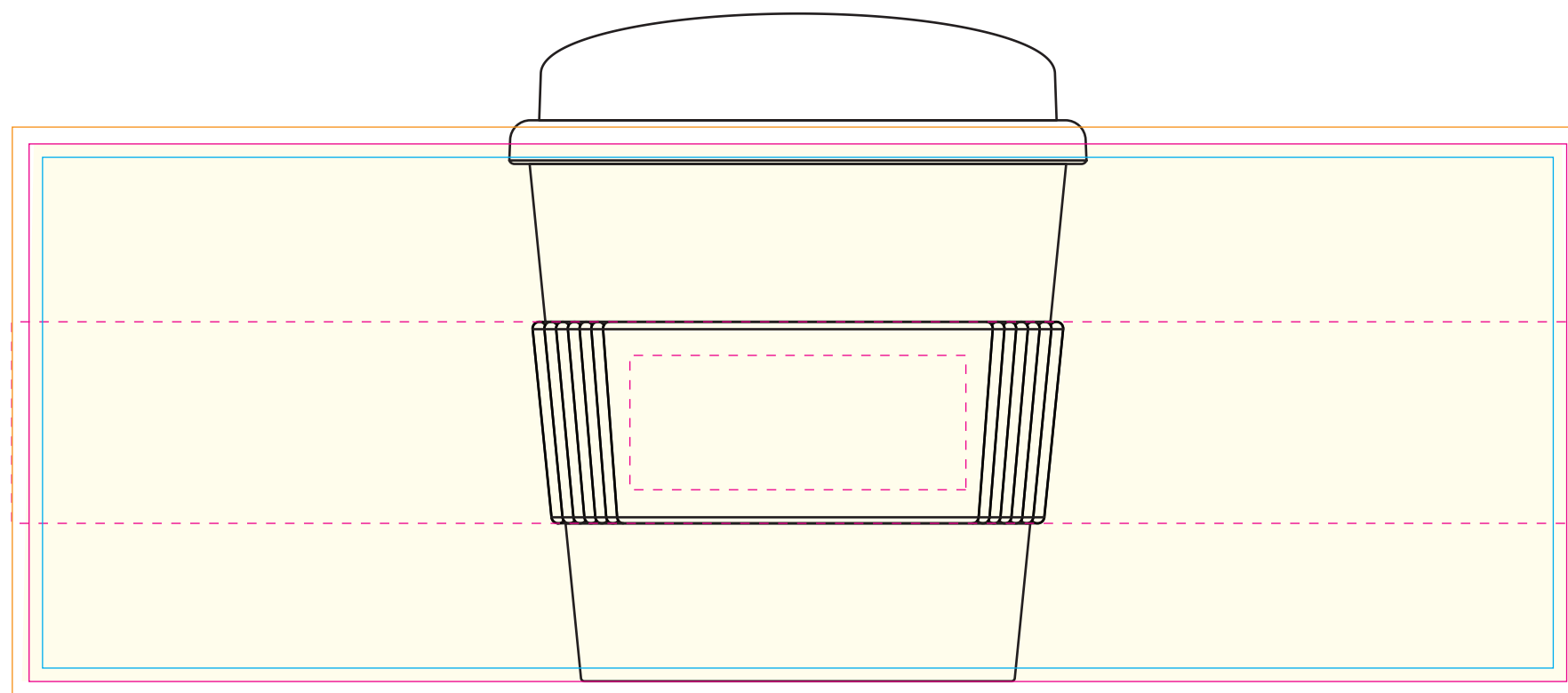

There will be a 2mm (approx.) white gap between where the label finishes and begins.

Available Print Area(s):

- Max Print Area (Grip) = 50x20mm
- Bleed Boundary (Mug) = 234x84mm
- Max Print Area (Mug) = 230x80mm
- Text limit (Mug) = 226x76mm

Notes For Artroom:

- **IMPORTANT:** Print colours available on the grip are:- Black, Cool Grey 7, Gold 871, Orange 165, Yellow 120, Silver, Blue 2195, Green 355, Red 2035, Purple 2685, Reflex Blue, White.
- Only 1 Colour Print Is Available On The Grip
- To Step and Repeat Mug Artwork Onto Curved Guides = -117mm